



COMAC CAL

**CZECH PRODUCER
AND DEVELOPER
OF MEASUREMENT
AND SENSOR TECHNOLOGY**

FLOW 38Imp Batch

Ver.8.24
(Impulse input)

Instalation and technical manual

Date of publish 27/05/2021

WWW.COMACCAL.COM

Content:

Warranty	4
Wiring	4
Important information	4
Installation of the meter's detached evaluation unit	5
Meter wiring of batching unit	6
Meter wiring of sensor	7
Electrical connection of the meter	7
Impuls output	8
Buttons START, STOP.....	9
Controlling of the batching valve.....	9
Data output.....	9
Protection degree.....	9
Replacement of tube fuse in the meter.....	9
Wiring check.....	10
Putting into operation.....	10
Flow 38 Batch operating instructions	12
Procedure to set individual menu items:	14
Date and time	15
Operation time counter.....	15
Power loss counter	15
Impulse output / flow switch.....	16
Impulse output.....	16
Flow switch.....	16
Setting of the range of dose.....	17
Communication.....	17
Idle state basic indications on display	18
Display dimming.....	19
Display backlight	19
Serial number	19
Impulse constant of external sensor	19
Empty tube test.....	19
Firmware version	20
Dead band – measurement start suppression	20
Zero calibration	20
Flow simulation.....	21
Language.....	21

Counter resetting	21
Nominal diameter (DN)	21
Flow direction	22
Flow units displayed [Q]	22
Volume units displayed [V]	22
Password change	22
Default settings (original factory settings)	23
Technical data	24
Servicing.....	25
Form for shipment of the meter back to COMAC CAL s.r.o.....	26

Warranty

Unprofessional installation or using the induction meters (devices) may result in a loss of warranty as well as failure to comply with installation or operating conditions according to this manual.

In case of returning the meters for inspection or repair to the COMAC CAL s.r.o. factory, enclose please the completed form, see the last page of this manual. Without having one, we will not be able to handle your requirement for modification or possibly repair your meter correctly and promptly.

Wiring

It is necessary that the installation worker has the owner of a valid certification for the installation of electrical equipment according to the legislation in the country where the installation is performed. When the operations described below are performed unprofessionally, the claim on warranty becomes extinct!!! Prior to any opening of the evaluation unit, switch off the power!!! It is necessary to bear in mind that in case of detached design, the electronic evaluation unit and the flow sensor form an integral unit which is calibrated and matched uniquely.

Important information

If it is possible to expect an increased level of unwanted electromagnetic field, we do not recommend using the detached design. In places with strong electromagnetic interference (in the proximity of frequency converters, electric motors, transformers, etc.), we recommend putting a line filter before the meter in the power supply circuit.

Evaluation unit

As standard, the evaluation unit is delivered for mains power supply 230V / 50÷60Hz.

For securing the tightness of the evaluation unit cover, it is necessary to keep the seal intact and clean (replace the damaged seal immediately). If the holes for cable entries are not occupied, it is necessary to do it.

The flow meter signal outputs may only be connected to devices where accident protection is provided by a safe low voltage and where generated voltages do not exceed the limits defined for safe low voltage.

In case of mains power 230V / 50÷60Hz, the meter is fed by a switched power supply which may contain beats in acoustic spectre whereas this symptom does not indicate a failure of the meter.

Never make kinks on the cable and on individual conductors and do not let them cross mutually in the terminal board area and always use a separate cable grommet for power supply.

Cover the unoccupied grommets with a piece of cable or a plastic plug (securing of tightness).

Installation of the meter's detached evaluation unit

Wall mounting:

For mounting on the wall are at the device indicated four mounting points forming a rectangle with dimension 106x186mm (total box height is 200 mm). These points then drill and place with the dowels, screws, install the unit to the wall and do the wiring. After completion, close the unit and tighten all screws.

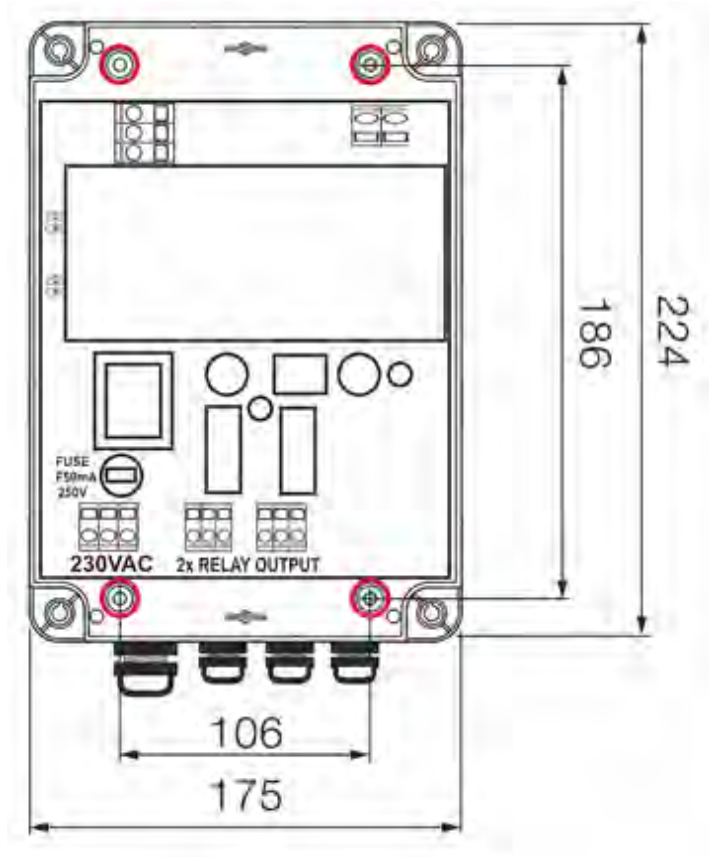

Total depth of box is 200mm!!!

Meter wiring of batching unit

The actual wiring is done by bringing electrical power supply wires 230VAC and controlling wire for the valve of one of two relay outputs (it is double output in case of damage to the first relay, or when there is a need to control two devices). Once the wiring is done, close the box and by fastening of the corner screws secure the cover against opening. Next use the connectors to connect the flow sensor cable. Fix the cable to the wall or structure so that it does not "hang" off the connector. Below the connector create a "drip loop" facing down so that any dripping water would not wet the connector. Similarly, fasten the wires for supply voltage and control outputs. At this stage the device is ready to operate. The internal control board is already connected with a measuring device – this has been done inside the COMAC CAL factory. If this is not desirable, do not interfere with the wiring.

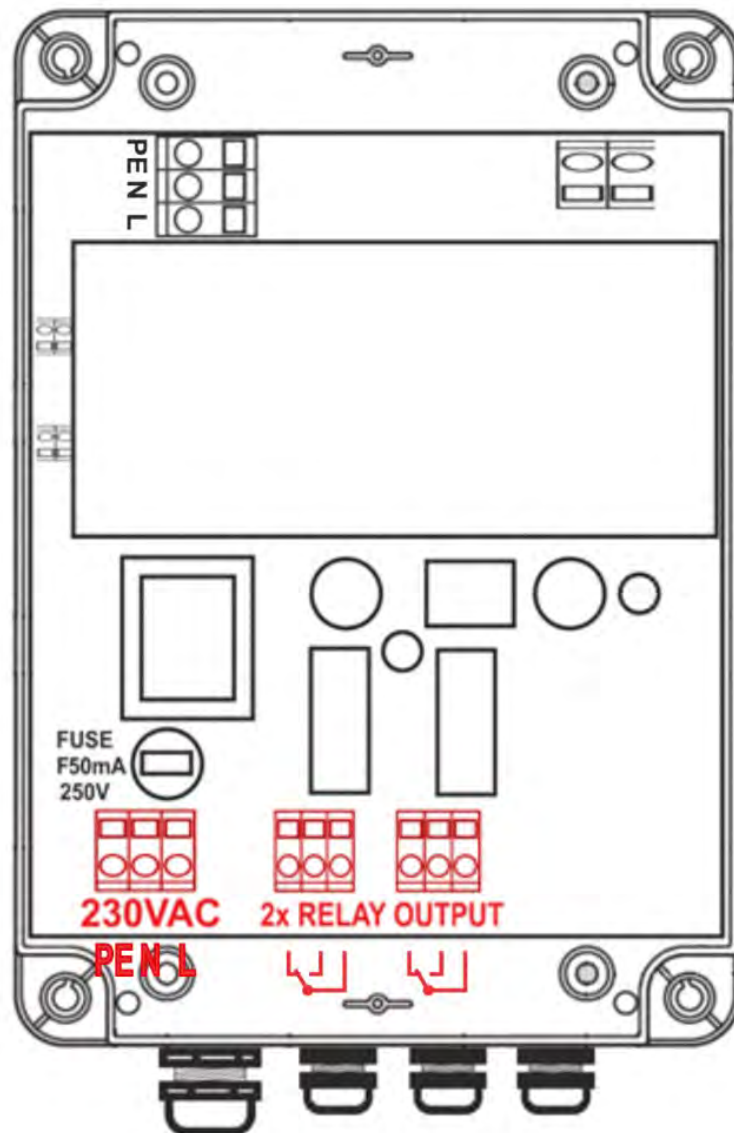

Meter wiring of sensor
(Standardly for inductive sensor is made in COMAC CAL factory)

Sensor cable connection using pulse output from flow meter sensor (not for inductive sensor):

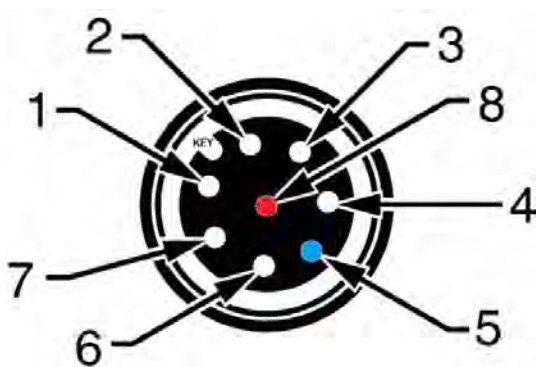

The sensor is connected via M12, 8-pin connector against the socket on the cover's body.

Pin5 GND
 Pin8 pulse input

Input is designed for connection to any meter with a voltage free or transistor output interface.
 Input includes internal pullup resistor 4k7. Voltage for pullup resistor is adjustable 5÷16V (default 5V)
 Coupling is capacitive.

Electrical connection of the meter
 (It is connected in the factory by default)

Evaluating unit is consists of two units:

Front panel with display unit

Back panel with outputs, inputs and power

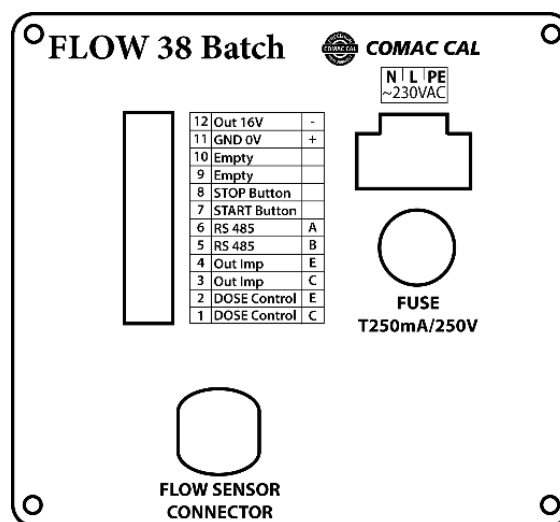
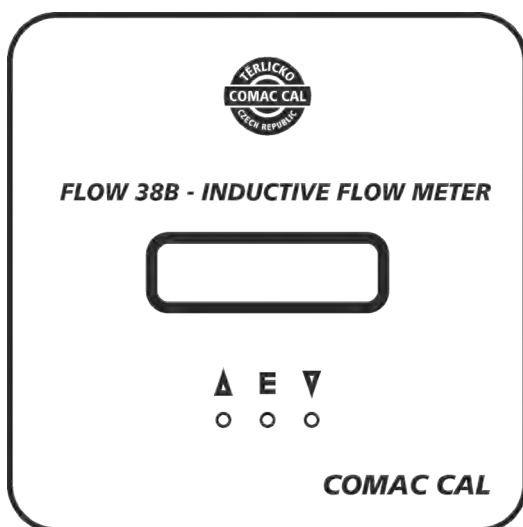

Terminal connection of the evaluation unit:

- Terminal 1 – controlling of batching valve C
- Terminal 2 – controlling of batching valve E
- Terminal 3, 4 – puls output OUT IMP
- Terminal 5, 6 – communication RS485
- Terminal 7 – START button
- Terminal 8 – STOP button
- Terminal 9,10 – none
- Terminal 11,12 – auxiliary voltage

These terminals are in the batching device already connected to the control supply plate.
Terminal connection and jumpers is always described on the cover sheet of power supply and back cover.

Impuls output

The output of volumetric impulses is implemented by an NPN transistor. Limit parameters of this optocoupler are 80V/50mA/100mW max.

The volumetric impulse output is used for remote transmission of volumetric impulses. The conversion constant is arbitrarily variable using buttons or user software. The adjustment must be carried in such a manner that $f_{out} < 400\text{Hz}$.

The impulse output may be active or passive.

In active mode, the meter takes advantage of internal galvanically isolated 16V power supply. The voltage at the output is in the state of 16V pulse, the recommended drawn current is 2.5mA. At the moment beyond the pulse, the output is at the state of high impedance (if the input of the device does not contain an internal pulldown resistor, it is necessary to provide it)

Wiring connection examples – passive impulse output:

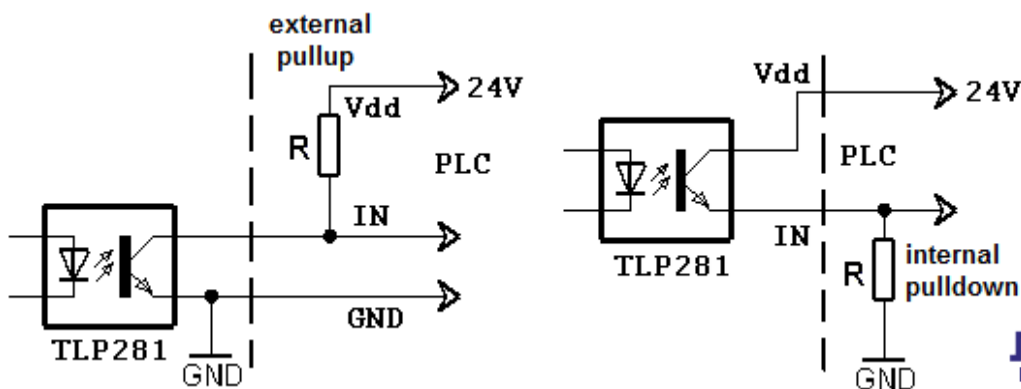

Terminals

12	Out 16V	-
11	GND 0V	+
10	Empty	
9	Empty	
8	STOP Button	
7	START Button	
6	RS 485	A
5	RS 485	B
4	Out Imp	E
3	Out Imp	C
2	DOSE Control	E
1	DOSE Control	C

Due to $CR \approx 100\%$ and $I_f = 2.5\text{ mA}$ it is advisable to choose the collector current up to 2.5 mA.

Buttons START, STOP

Applying a signal to the GND terminal 7 or 8 you can start or stop the batch. These terminals are in batching devices already connected to the control buttons.

Controlling of the batching valve

Terminals 1 and 2 are used to control the relay valve batching device. These terminals are in batching devices already connected to the control board with relay outputs.

Data output

The Flow 38 Batch meter can be provided with RS485 communication interface with M-Bus protocol according to EN 1434-3 or ModBus RTU.

Protection degree

The meters meet all the requirements for IP 65 protection degree.

Replacement of tube fuse in the meter

!!! Risk of electric shock! Uncovered components generate dangerous voltages. Before removing the cover from the electronics area, make sure that the meter is not under voltage!!!

The instrument fuse is on the power supply PCB and it is replaced as follows:

1. Switch off power.
2. Unlock the corner screws and remove the cover instrument boxes
3. Remove the protective cover and replace the instrument fuse (use solely F50mA/250V tube fuses for power source part and F250mA/250V for measuring part)
4. Proceed in reverse order to recover the function of the meter.

power source part

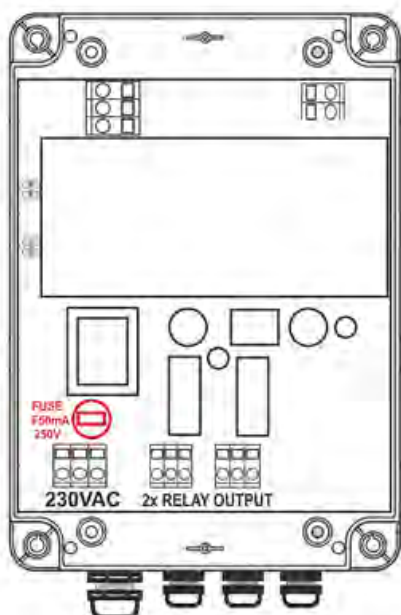

measuring part

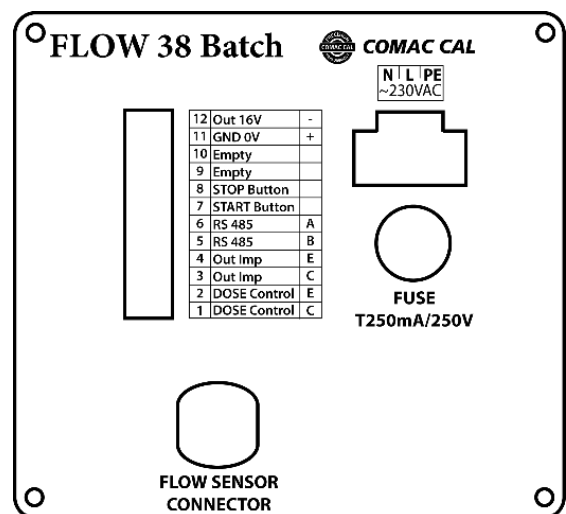

Wiring check

After completion of wiring, it is necessary to check:

- Connecting cables for damage.
- If the cables used are suitable for given cable entries.
- Cables for pull relief.
- Correct tightening of cable entries.
- Correct connection of cables to terminals.
- Whether the supply voltage corresponds with the nameplate data.
- After closing the device properly tightening the lid.

Putting into operation

Prior to connection to power supply, check the device installation accuracy in accordance with “Installation in pipeline and “Wiring” chapters.

If you wish the meter to take measurement as precisely as possible right after powering up, it is a good idea to fill the flow sensor with water, one or two days before its installation, so that all of its electrodes are flooded. Just before the installation, the water is discharged and the sensor is installed into piping. Right after installation, piping is filled with a medium so that the electrodes cannot dry off.

If the meter has no electrode for empty tube detection, do not connect the meter to power before filling the system with the fluid to be measured and power off the meter before system discharge.

Once the meter is powered up, the green LED on the front glazed panel is lit, confirming the supply voltage on the control PCB and stabilization of parameters of the meter takes place subsequently. The stabilization is indicated on the meter's display. After that period of time, the meter starts measuring.

Meter status:

It is displayed continuously on the screen as one of the main menu items and in case of a non-standard state or a failure, this is displayed by alternating indication of the status and main menu basic data and the operator is warned by a text. The meter status is divided into 4 basic groups:

- | | |
|------------|---|
| 1) OK | everything is all right |
| 2) Warning | the meter takes measurement but some of the parameters are out of range |
| 3) Error | critical error – the meter does not take measurement |

Flow direction:

The arrow indicates the direction liquid flow inside the sensor and thus the correct orientation of the meter's sensor for installation in piping. In case of inversely performed installation, it is possible to toggle the direction in electronics between positive/negative and thus avoid incorrect value imaging and reading out.

Basic parameter settings

The meter or flow meter parameters are set by the manufacturer in accordance with the purchase order. If these values are not indicated in your purchase order, the meter will be set up using the default parameters in accordance with the meter's range. The operator can make modifications by means of three buttons on the meter's panel or through the RS485 interface.

Safety rules for operator

Any interventions in the inductive flow sensor and evaluation unit itself are illegal on the part of operator and they may lead to direct scalding by medium. Perform electrical connection always after powering off.

Flow 38 Batch operating instructions

The meter is provided with two external buttons on the side of the electronics housing and with three internal buttons on the bottom of the measuring electronics PCB which is accessible after unscrewing the front glazed cover.

Functions of control (lower) buttons:

Potentiometer	Setting the batch size, the minimum setting value of the potentiometer corresponds to the limit for the minimal batch and maximum value of the potentiometer then the maximal batch (see p. 26).
Green "START" button	Start the set dose from the beginning, or its restart, if the previous stop red button.
Red "STOP" button	Stop ongoing dose. In the case the batch is stopped yet, than this unfinished dose is cancelled and the unit is ready to be restarted dose again from the beginning of the green button.

Function of setting buttons (under display)

Before pressing E and entering the password

▲	short press	movement in current menu up or modification of the value at the cursor up
▼	short press	movement in current menu down or modification of the value at the cursor down
▲ / E	long press (>3sec)	entry to PARAMETERS menu
▼	long press (>3sec)	exits from PARAMETERS menu
◆	simultaneously ▲ and ▼ (short press approx. 0.5sec)	resetting user rV counter in PARAMETERS menu while entering values by an order back
◆	simultaneously ▲ and ▼ (long press >3sec)	in PARAMETERS menu, end of modification of values without writing
◆	simultaneously ▲ and ▼ (long press >8sec)	total restart of the meter
E	short press	confirmation (Enter) or modification of a value (setting)



Basic display menu contains the following items:

Date and Time	D/T
Current flow	Q
Dose setting	Vrun/stop
Volume in positive direction against the arrow on the meter's name plate	+ V
Volume in negative direction against the arrow on the meter's name plate	- V
Total volume (summary in both directions)	Σ V
Dose volume (in positive direction only)	r V
Status	OK

The order may vary as per meter's settings the customers may select the data to be displayed on the first two lines (or change the order) in such a manner that corresponds to their requirements.

In case that the meter's status is found in a different than normal and correct (OK) status, measurement failure indication alternates with the normal display indication. As a consequence, it is not necessary to check the status all the time; in case of trouble, it is indicated on the display unit automatically.

Using both external and internal ▲ and ▼ buttons, you can list in basic menu, reset the user volumetric counter (by simultaneous pressing both buttons), enter PARAMETERS menu, list in it and exit from it.

Parameter settings menu contains these following items:

DATE AND TIME
OPERATION TIME COUNTER
POWER LOSS COUNTER
IMPULSE OUTPUT or FLOW SWITCH
SETTING OF THE RANGE OF DOSE
COMMUNICATION
BASIC INDICATIONS ON DISPLAY
DISPLAY DIMMING
DISPLAY BACKLIGHT
SERIAL NUMBER
IMPULSE CONSTANT OF EXTERNAL SENSOR
EMPTY TUBE TEST
FIRMWARE VERSION
DEAD BAND – MEASUREMENT START SUPPRESSION*
ZERO CALIBRATION*
FLOW SIMULATION
LANGUAGE
COUNTER RESETTING*
NOMINAL DIAMETER (DN)
FLOW DIRECTION*
FLOW UNITS DISPLAYED [Q]
VOLUME UNITS DISPLAYED [V]*
PASSWORD CHANGE
DEFAULT SETTINGS (ORIGINAL FACTORY SETTINGS)

** If the meter is delivered for billing purposes, then these parameters marked with an asterisk cannot be changed (in case of restoration of factory settings, the volumetric counter is not reset).*

For editing items in PARAMETERS menu, the central **E** button is used, once it is pressed down, the operator is asked for authorization of access by password (by default, it is **0000**). Consequently, it is possible to use the ▲ and ▼ buttons to change the value upwards or downwards and confirm the modification by the central **E** button. In case that the parameter to be changed is not a numerical one, the entire parameter is changed by means of a "scroll bar". The password is required only at the first

entry and it will become invalid after returning to basic display or within two and a half minutes of inactivity when the meter returns again to its basic display automatically

Examples of representation in normal status according to user settings:

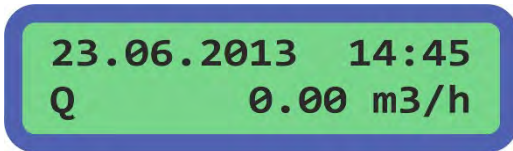

23.06.2013 14:45
Q 0.00 m3/h



Q 12.832 m3/h
+V 63439.2 m3



ΣV 2113.45 m3
rV 3.42 L

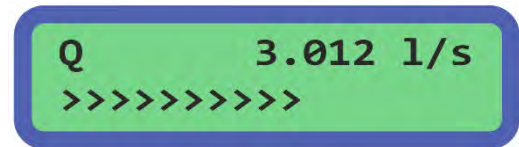

Q 3.012 l/s
>>>>>>>>>>

Note: The order of representation of menu items can be modified by user according to the customer's needs.

Procedure to set individual menu items:

Within framework of setting, it is necessary to unscrew the front cover with glass window to get access to internal buttons. After initial entry to Parameter's menu (long press of \blacktriangle) and an attempt to edit an item (by E button), the operator is asked for entering an authorization access code (by default **0000**). This is entered successively for each of four digits separately from left to right using the \blacktriangle or \blacktriangledown buttons whereas the transfer of cursor to another digit, including the final confirmation of the entire code is implemented by the E button. By applying a double press \blacklozenge (simultaneously \blacktriangle and \blacktriangledown short press approx. 0.5sec) you can return by one position and correct it. In case of entering an invalid password, modification of parameters is not enabled and the password entry must be repeated.



Password: 0000

Note: The password will become invalid after returning to basic display or within two and a half minutes of inactivity when the meter returns again to its basic display automatically.

Entering numerical values for individual menu items takes place in a similar manner.

If it is not a freely adjustable numerical item but a list of possible values, the selection is implemented by successive scrolling using the \blacktriangle or \blacktriangledown buttons and once the desired value is displayed, you simply confirm the selection by pressing the E button.

After successful entry, the confirmation of the request for modification is required by the \blacktriangle or \blacktriangledown buttons, followed by selecting YES/NO and confirming by the E button. By doing this, the modification is saved in the internal memory of the meter.

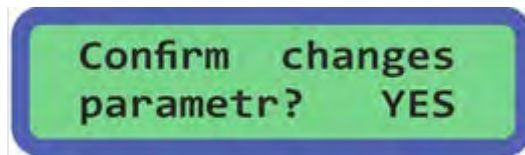

Date and time

This menu item is in DD/MM/RRRR HH/MM formats

Use the ▲ and ▼ buttons to set the menu item on the display and press the E to edit. Implement settings in a standard way, using the setting buttons and confirm by pressing the E button.

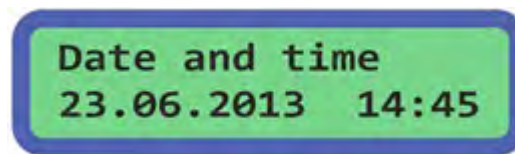

It is necessary again to confirm the change.

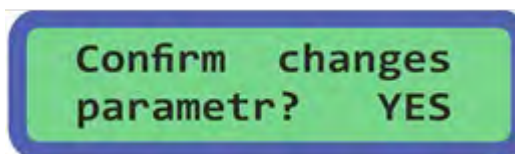

Operation time counter

The counter registers the operation time of the meter (switching on). The first line indicates the date when the last counter reset was performed and the second line indicates the length of operation in days, hours and minutes.

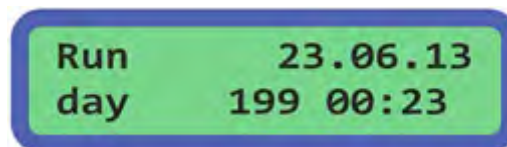

This counter can be reset by pressing the E button when necessary.

Power loss counter

The counter registers the time of loss of power time for the meter. The first line indicates the date when the last reset of power loss counter was performed and the second line indicates the length of time when the meter was out of operation in days, hours and minutes. The counter can be reset again by pressing the E button.

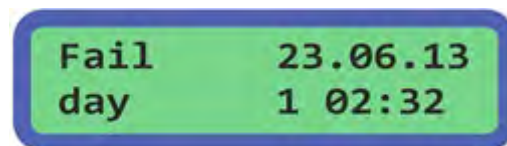

Impulse output / flow switch

This output can be configured as the impulse output or the Flow Switch contact.

Impulse output

For complete setting the parameters of impulse output, it is possible to change the logics (polarity) of the electrical signal (positive/negative), to set the impulse output to which the volumetric counter will respond (volume run in positive direction, in opposite direction and in both directions) as well as your own impulse constant, including its indication (imp/L or L/imp).

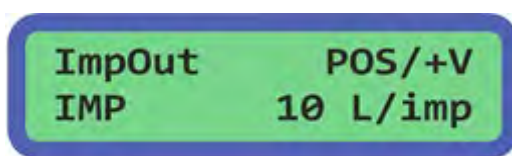

The impulse width cannot be set freely using an arbitrary value but it is necessary to select a suitable impulse width from the predefined width menu (by scrolling the predefined values using the ▲ or ▼ buttons).

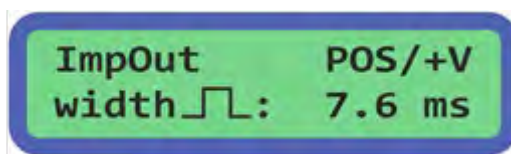

Flow switch

For complete setting the parameters of status output, it is possible to change the logics (polarity) of the electrical signal (positive/negative) and then set to which volume the output will respond (flow in positive direction, in opposite direction and in both directions) as well as your own switching point value.

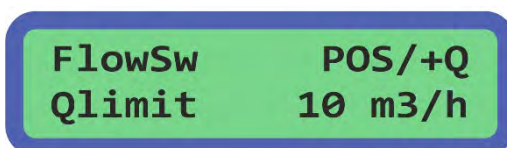

The status contact makes it possible to set the amount of hysteresis between Qon and Qoff states.

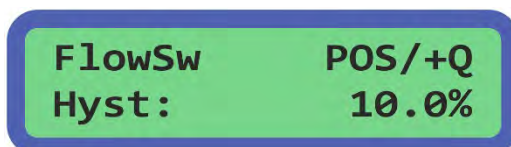

Setting of the range of dose

For Setting dose range uses two parameters, which set the maximum and minimum of dose between the rotary element. Selecting of the maximum value automatically affects the resolution in which it is possible to adjust the dose so that was the setting value by rotary buttons stable - usually can figure set to 3 significant figures (999 position of rotary switch). It means for settled max. dose 1000 litres will be one step 10 litres changing by the rotary switch etc.

Setting then proceeds in a conventional way by changing the dose in m3 for the minimum, and consequently the maximum limit.

Set Dose [Min]
Vstop 0.002 m3

Set Dose [Max]
Vstop 0.200 m3

Communication

If the meter is ordered with communication, it is possible to set all of its parameters. For selection of an address, any number 0 – 255 can be set and the velocity should be selected according to custom practice. If you wish to change the type of communication, press the E button. Then press \blacklozenge (simultaneously \blacktriangle and \blacktriangledown approx. >0.5sec). Select the desired communication type by \blacktriangle or \blacktriangledown and confirm the selection by the E button.

Once the MBus/MODBUS type of protocol is to be changed, the recommended velocity for these communication types is completed automatically.

Rs485: MODBUS
Adr: 157 9600Bd

Rs485: MBUS
Adr: 001 9600Bd

Rs485:
not available

If communication was not ordered.

Idle state basic indications on display

Basic indications in idle state can be influenced and modified in such a manner that the data needed by the user can be found on the first two lines on the display. Whereas the order of the other items is retained. If you want to change a setting, press the E and ▲ or ▼ buttons and select the data on the line which is then confirmed by the E button. The customer can select from these indications, namely both on the first and the second lines:

- Date and Time
- Dose volume user defined volume rV
- Total volume $\sum V$ sum of volumes in both directions
- Volume (-) direction reverse flow volume -V
- Volume (+) direction volume in positive flow direction +V
- Dose setting
- Flow current flow Q

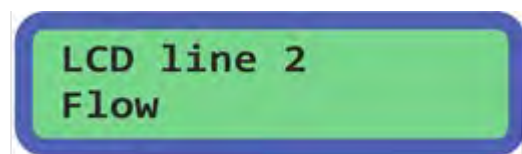
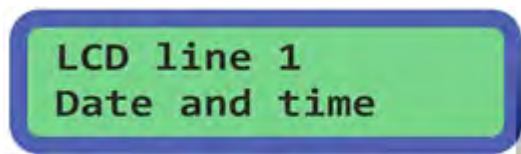

Display dimming

The period of averaging flow values within the range is set here. Maximum value is 29sec. Averaging is then used for the other outputs as well.

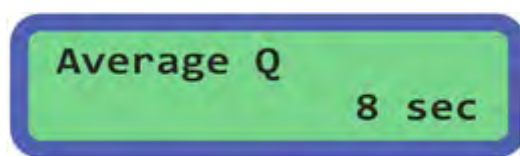

Display backlight

Here, you can set the period during which the display backlight is turned off after the last activation of a button. Use the ▲ and ▼ buttons to select the desired settings from menu (permanent, 40sec, 20sec, 10sec, switched off).

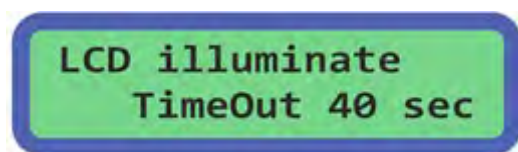

Serial number

The serial number is registered in the factory and cannot be changed by user.

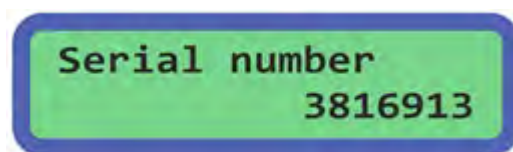

Impulse constant of external sensor

Allows you to set the pulse constant of the external flow sensor.

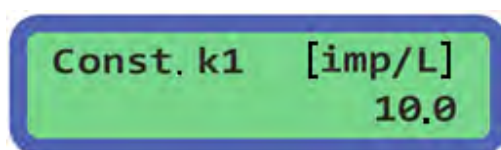

Empty tube test

Activates and deactivates monitoring of measuring tube filling. If the meter was ordered without the testing electrode, the flooding test cannot be activated. Two levels of the empty tube test activation are available for standard conductivity ON(1) and for increased conductivity ON(2).

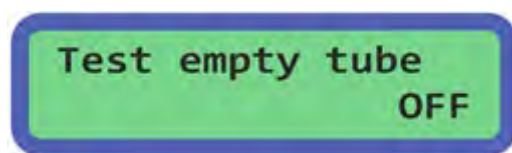

Firmware version

The firmware version is registered in the factory and cannot be changed by user.

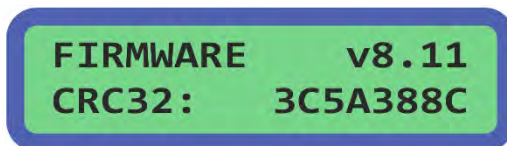

Dead band – measurement start suppression

If you want to change the flow value for the start of measurement, press the E button.

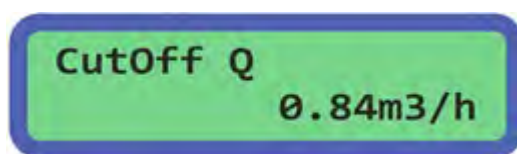

Zero calibration

The date under "Zero calibration" heading indicates the date when zero flow calibration was performed.



If you want to recalibrate the zero flow, press the E button. The flow meter evaluates the measured data automatically and if YES is set, upon confirmation of the selection by the E button, a new value for zero flow will be set and the date of the last recalibration is updated (when NO is selected, the value for recalibration is not registered and everything remains in original setting).

Note: Before recalibration is performed, do not forget to close the valves first and secure a real zero flow (stationary medium) in the system.

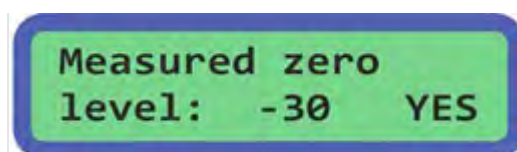

Flow simulation

Flow simulation serves for comfortable setting and checking the systems in which the flow meter is used without necessity to use realistic flow of medium through the meter and without necessary installation of the meter in the pipeline. The display shows the simulated flow and current and impulse outputs of the meter correspond to this data. Such a simulated flow is not registered in the volume registry, of course.

WARNING! If the meter runs in simulation flow mode, it does not return automatically after two and a half minutes as it is typical for all other modes and representations. After termination of flow simulation mode, it is necessary to exit Parameters menu by the (▼ long press >3sec) button!!!

The customer can set the value of the simulated flow. If you want to activate or deactivate the simulation, press the E button.

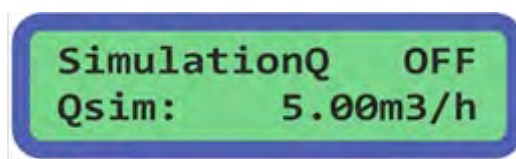

Language

If you want to change the meter's language, press E and then select a desired language from menu.

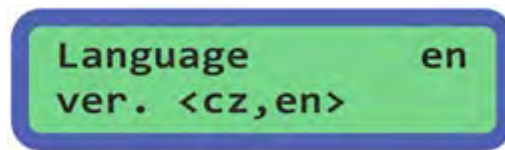

Counter resetting

Here, it is possible to reset all or only certain volumetric counters. If you want to perform resetting, press E and select which counter you wish to reset (ΣV , -V, +V or all). After resetting, the date when the last reset was performed is displayed and which counter was reset (again, ΣV , -V, +V or all).

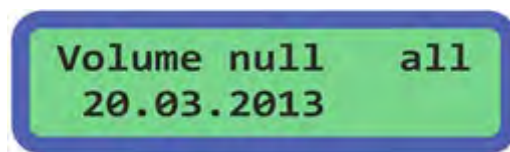

Nominal diameter (DN)

This parameter is set in the factory and cannot be changed.



Flow direction

Specifies the direction of flow in the flow sensor with respect to the data in electronics. Positive direction is the flow in the sensor identical to the arrow indicated on the meter' name plate. If the medium flows through the sensor against the arrow on the sensor, select the NEGATIVE direction.

If you wish to make the change, press E.

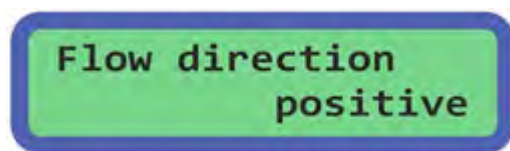

Flow units displayed [Q]

If you wish to change the way of flow indication, press E .

Use the ▲ and ▼ buttons to set the required number of decimal places and by confirming with E, go to setting the flow unit representation.

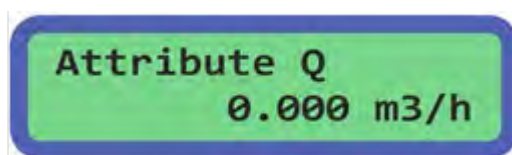

Volume units displayed [V]

To change the way of volumetric indication (+V, -V and ΣV), press E. The number of decimal places for the volumetric counters can be selected from 3 to none. Furthermore, the selection of units is here (L, m³). If these parameters are changed, the respective measured value will be changed as well. In consequence, we recommend resetting of the counters changed in this way after reconfiguration.

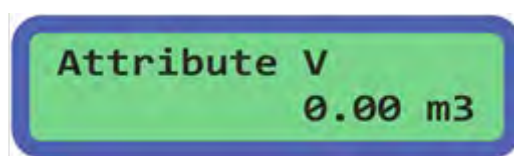

Password change

The password for modification of the customer parameters is set by default to **0000**. However, the user can change it in this window by pressing E. The access code must have 4 digits.

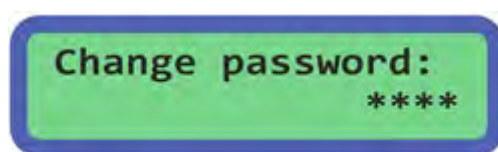

Default settings (original factory settings)

During activation of this function, the configuration of the meter will be restored to the factory default state in which it was shipped. All user settings will be deleted and if the metrology jumper J1 on the power supply board is connected (non-certified meter used for **non-billing** purposes), all volumetric counters will be reset as well.

The user password is cancelled and the access code is reset to original (0000).

This applies to calibration of the meter as well. Before activating this function, it is useful to record or make a backup of the data of all counters.



This function can be activated without the access code!

If you wish to apply the original factory settings, press E and use the ▲ or ▼ button to select YES from menu and then confirm by E.

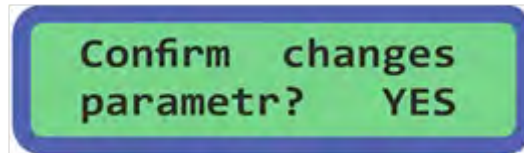

After confirmation of the change, the meter will have the settings it had when it was delivered by the manufacturer.

Technical data

Evaluation electronics technical parameters

Supply voltage:	230V AC (+10; -20%) 50 ÷ 60Hz	(standard)
Input power:	4.6VA	
Display:	LCD 2 x 16 characters, backlit	
Displayed values:	flow – m ³ /h; L/h; L/min; L/s; positive, negative volume – m ³ ; L; positive, negative, sum in both directions	
Controls:	2× external button (START / STOP) 3× internal button (viewing + parameter modification)	
Inputs:	buttons START / STOP	
Output's:	impulse (max. 400 Hz, passive),	
Communication:	RS485 (M-BUS/Mod-Bus protocol)	
Display response:	1.28 s	
Design	separate (standard cable length 3 m)	
Cable entries	LH (mains) 1 x cable max.φ 9 mm RH (outputs) 1 x cable max.φ 7 mm	
Ambient temperature:	5 ÷ 55°C	
Ambient humidity:	max. 90%	
Head size:	220 x 170 x 80 mm (H x W x D),	
Weight:	2540 g (evaluation unit in detached version)	
Material:	ABS plastic	
Max. ambient temperature:	55 °C	
Electronics protection:	IP65	

If you do not find your size or structure in the Flow sensor technical parameters Table, it is a special or non-standard design. In this case, find the information on the sensor nameplate where this information is always indicated, or please contact the manufacturer for more detailed information.

Servicing

When the operations described below are carried out incompetently, the claim for warranty for errors resulting from this becomes null and void!!!

Turn off the power every time the evaluation unit is opened!!!

All repairs within warranty and after warranty period are only conducted by the manufacturer,
COMAC CAL s. r.o.

Form for shipment of the meter back to COMAC CAL s.r.o.

The meter you have was made with the maximum precision and it has been checked many times and wet calibrated.

If the meter is used in agreement with this manual, the occurrence of faults is very rare. Should they ever occur, contact our service department. If you return the meter to the manufacturing plant, adhere to the conditions stated below:

- Clear the meter of contaminations stuck to the sensor and measuring tube (eventually to the Evaluation Unit).
- If the meter was run with poisonous, etching, combustible liquids or with fluids dangerous to water, check it and if appropriate, flush and neutralize the cavities inside the sensor.

Fill in the following data please and the form duly completed attach to your consignment. COMAC CAL s.r.o. will not be able to process your request promptly and correctly without this form.

Customer

Company..... City.....
Department..... Name.....
Phone no.....

Enclosed meter

Type..... Serial number.....
Measured liquid.....

Description of a fault or modifications required.....
.....
.....
.....

We confirm that the meter was duly cleaned, and if required, it was flushed out and neutralized. Therefore, this consignment does not constitute any risk to humans and environment due to remnants of the measured fluid.

Date..... Signature and stamp.....