



COMAC CAL

**CZECH PRODUCER
AND DEVELOPER
OF MEASUREMENT
AND SENSOR TECHNOLOGY**

Flow monitor FS 20

Switch contact with 4 – 20mA outputs (with measuring of velocity)
Ver.1.9

Installation and technical conditions

Issued 18/6/2019

WWW.COMACCAL.COM

Contents:

Unit description	3
Scope of delivery	3
Process connection	3
Storage conditions	3
Warranty	3
Installation in piping.....	4
Important information for selection of placement.....	4
Interference sources.....	5
Electrical installation.....	6
Meter wiring	6
NO/NC contact	7
OUTPUT 4-20mA.....	8
Starting up	9
FS 20 monitor adaptation and control.....	11
Switching point.....	11
Customizing to a medium different from water (oil, glycol-based mixtures, etc.).....	11
Calibration of the minimum flow of the monitor	11
Calibration of the maximum flow of the monitor.....	12
Restoring parameters to factory default values	12
Technical specification	13
Basic dimensions	14
Additional accessories	15
Adapter block	15
Order code.....	15

Unit description

The FS 20 flow monitor is designed for liquids and is based on the calorimetric measuring principle, according to which the flow rate of the measured liquid is proportional to the function of heat transfer from the sensor to the surroundings. Prompt and simple installation and lower costs thanks to its simple construction are the principal advantages.

The sensors are not restricted by the electrical conductivity of the liquid. Owing to the calorimetric measuring principle used, the measurement is dependent on thermal conductivity of the liquid. The meter can reach its highest sensitivity within the range of $4 \div 150$ cm/s for use with water. For other liquids with different thermal conductivity, the measuring range is different. The measuring range can be modified by user to a certain extent, whereas it holds true that the lower thermal conductivity of medium, the higher flow rates can be measured.

Scope of delivery

The unit is delivered separately without other additional elements and is ready for installation with a process connection by means of the adapter for cutting ring couplings according to EN ISO 8434-1 (DIN 2353) with the 24° cone.

Process connection

The FS 20 flow monitor is usually delivered with a stainless steel sleeve nut M16x1.5 and with installed stainless steel cutting ring in the position that allows maximum insertion of the sensor into piping. After installation of the stainless steel cutting ring onto the sensor, it is not possible to change the depth of insertion of the sensor into piping; it is only possible when the PTFE ring is used special order necessary.

The accessories to the flow sensor may include various necks (adapters) serving for process installation and M12 (4-pin) connectors for electrical connection. However, these are not included in delivery due to standard solutions of individual elements and so these may be delivered by other manufacturers of such elements.

For hygienic process connection is flowswitch delivered in version with CLAMP connection.

Storage conditions

The temperature during transportation and storage of the meter must be within the range of -10 °C up to 80°C.

Warranty

Unprofessional installation or using the flow sensors (meters) can result in a loss of warranty as well as the failure to follow installation or operating conditions according to this manual.

Repairs are not possible. The warranty becomes null and void by repairing or any intervention in the device carried out by any other person than manufacturer.

Installation in piping

Important information for selection of placement

Outdoor conditions

It is necessary to ensure that the sensor is not directly exposed to climatic factors and the measured liquid round the the sensor cannot freeze up which might lead to direct damage to the sensor itself.

In case of outdoor location, the manufacturer recommends using a protective shelter to avoid direct sun radiation so that the evaluation electronics cannot get overheated.

Vibration

The scope and level of vibrations must be below 2.2 g in the range of 20 ÷ 50Hz frequencies according to IEC 068-2-34 standard.

Actual placement

The flow detector (sensor), particularly its tip must be fully immersed (see Fig. a). For this reason, we do not recommend installing in the highest point of piping that may become aerated, or in sloping or even in horizontal piping with the open end into which air may penetrate, but conversely, in rising piping (see Fig. b).

Furthermore, the distance of the sensor tip from piping should be more than 11mm (see Fig. c).

During long-lasting measurements of very low flow rates ($Q < 0.1$ m/s), impurities may be deposited. In this case, carry out installation at horizontal piping sideways (see Fig. d).

Installation examples

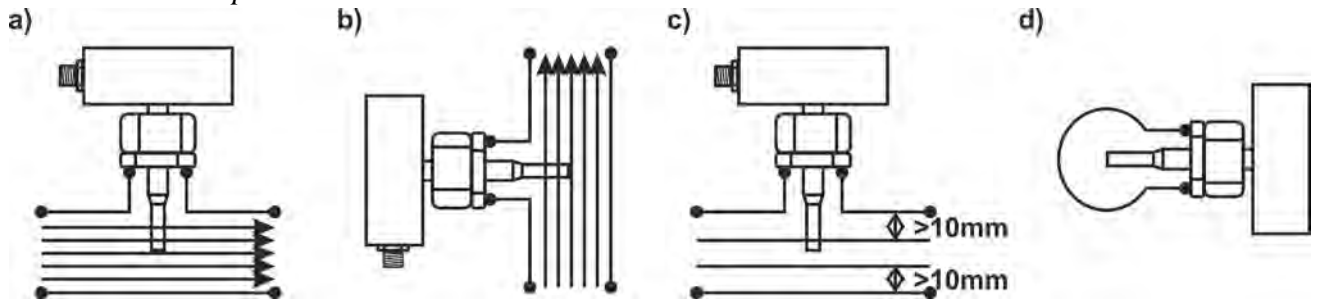

The flow of liquid in the flow detector should be **settled and free of whirls**. The sources of interference may substantially decrease the accuracy. For this reason, the location of the sensor is selected in such a way that there are sufficiently straight pipe segments before and after it. The minimum length of straight segments is $(5\div 10)\times d$ before the sensor and $(3\div 5)\times d$ after the flow sensor where d is the pipe diameter. In the prescribed straight sections, **no sources of interference** of the stable flow must be found. They must be located in the pipe after the flow sensor, or at the longest distance before it.

When a mixture of substances is made, you need to install the flow meter either before the mixing location or at a sufficient distance after it ($\text{min.}30\times d$), otherwise the indication may be unstable.

Mounting procedure

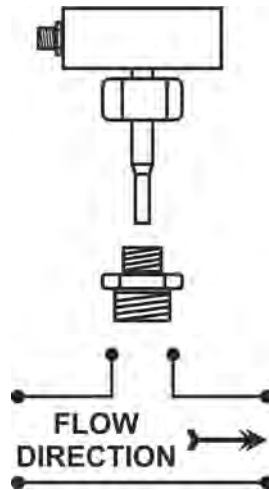

Before mounting is started, make sure that the system is depressurized or discharged. After that, install a suitable adapter to a T-piece or in some case in a welded-on piece or right on the pipe wall with adequate thread sealing. Then install the flow monitor in the adapter. In case of the stainless steel cutting ring, the length of insertion of the sensor in the adapter is given by the assembly of the built-in ring and cannot be changed. The length of insertion of the sensor can only be changed when using a ring made of PTFE. Tighten the stainless steel ring sleeve nut with the torque of 70Nm max. (in case of PTFE ring, 50Nm max).

When installed in piping and for the most precise flow evaluation, adhere to the orientation of the unit so that the M12 connector (cable gland in the case of a separate version) for electrical connection can form an upstream edge. So the medium should run from the same side where this connector (cable gland) is found.

Interference sources

The most frequent interference sources affecting the stable flow of liquid are as follows:

- The flow of liquid in the flow detector should be **settled and free of whirls**. Minimal recommended distances of the straight pipe section are 5xd before and 3xd after sensor.
- Pumps and bends or elbows located closely one after another in various planes. These elements should be found at least at a distance of 20×d (where d is the inside diameter of the meter in millimetres) before the flow sensor.
- Abrupt variations of pipe cross-section if not made as a cone with an angle of $\alpha \leq 10^\circ$ (where α is the angle made by bevelled walls of the pipe adapter).
- Whatever interfering in the flow of liquid.
- Branch lines, T-pieces, bends, elbows, slide valves, taps, flaps. Shut-off valves, control valves, butterfly valves and non-return valves. Pipe outputs from reservoirs, exchangers and filters.
- When a mixture of substances is made (or mixture of the same liquids with different temperatures) you need to install the flow meter either before the mixing location or at a sufficient distance after it (min.30xd), otherwise the indication may be unstable.

Electrical installation

Always carry out any handling operations or installation of the device after disconnection of the supply voltage!!! When the below mentioned operations are carried out unprofessionally, the claim to warranty become null and void !!!

Meter wiring

M12 connector wiring (compact version):

The flow monitor is equipped with a standard M12x1 connector with 4 pins.

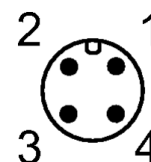

The pin connection corresponds to the type of outputs and is shown on the tagplate of sensor.

FS 20 – PNP

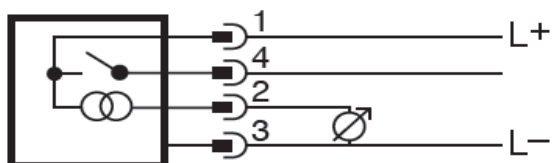

Standard switch contact connection:

- PIN 1 – supply voltage +24V
- PIN 2 – outputs 4-20mA
- PIN 3 – supply voltage GND
- PIN 4 – PNP contact switch point

FS 20 – NPN

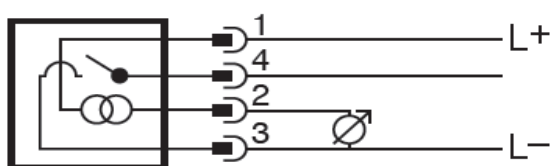

- PIN 1 – supply voltage +24V
- PIN 2 – output 4-20mA
- PIN 3 – supply voltage GND
- PIN 4 – NPN contact switch point

As a standard, the evaluation unit delivered for 24VDC \pm 10%, 150mA power. The signal outputs of the monitor may be connected only to devices where the personal accident protection is ensured by a safe low voltage and where the generated voltages do not exceed limits specified for safe low voltage.

Note: Connector wiring is always indicated on the label found on the sensor housing.

NO/NC contact

The manufacturer delivers the meter with the switching point set as a contact maker unit. If the flow rate on compact version is above switching point, relay contact on pin 2 and pin 4 is closed (eventually is closed PNP/NPN contact on pin 4). If the flow rate is below switching point, relay contact is open.

The typical response time is $1 \div 6$ sec and it is influenced by the rate of change of flow:

- The change of flow moves close to the switching point – slower response.
- The change of flow jumps over the switching point – quick response

The designation of a switching point on the LED scale can be implemented in two colours that indicate simultaneously if the switching contact is closed or open:

- Red LED – open contact
- Amber LED – closed contact

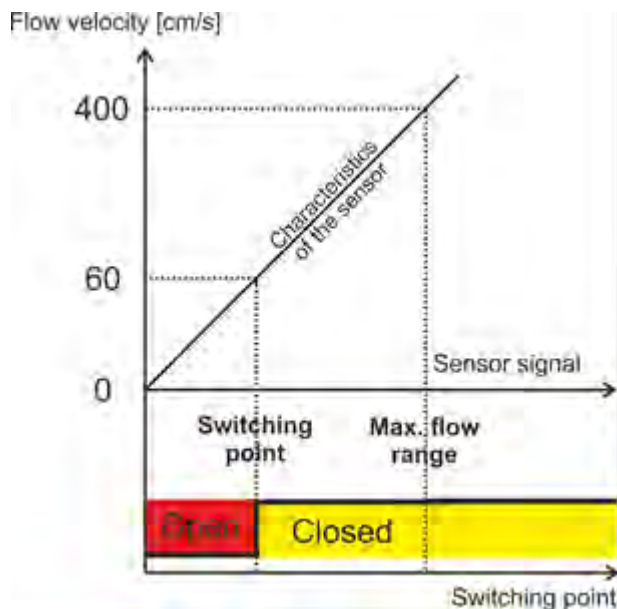

OUTPUT 4-20mA

The factory setting of FS20 is delivered with the output 4 - 20 mA, that at zero flow velocity output value is 4 mA and at 4 m / s is output value 20 mA. The dependence of the power on speed of flow is not linear.

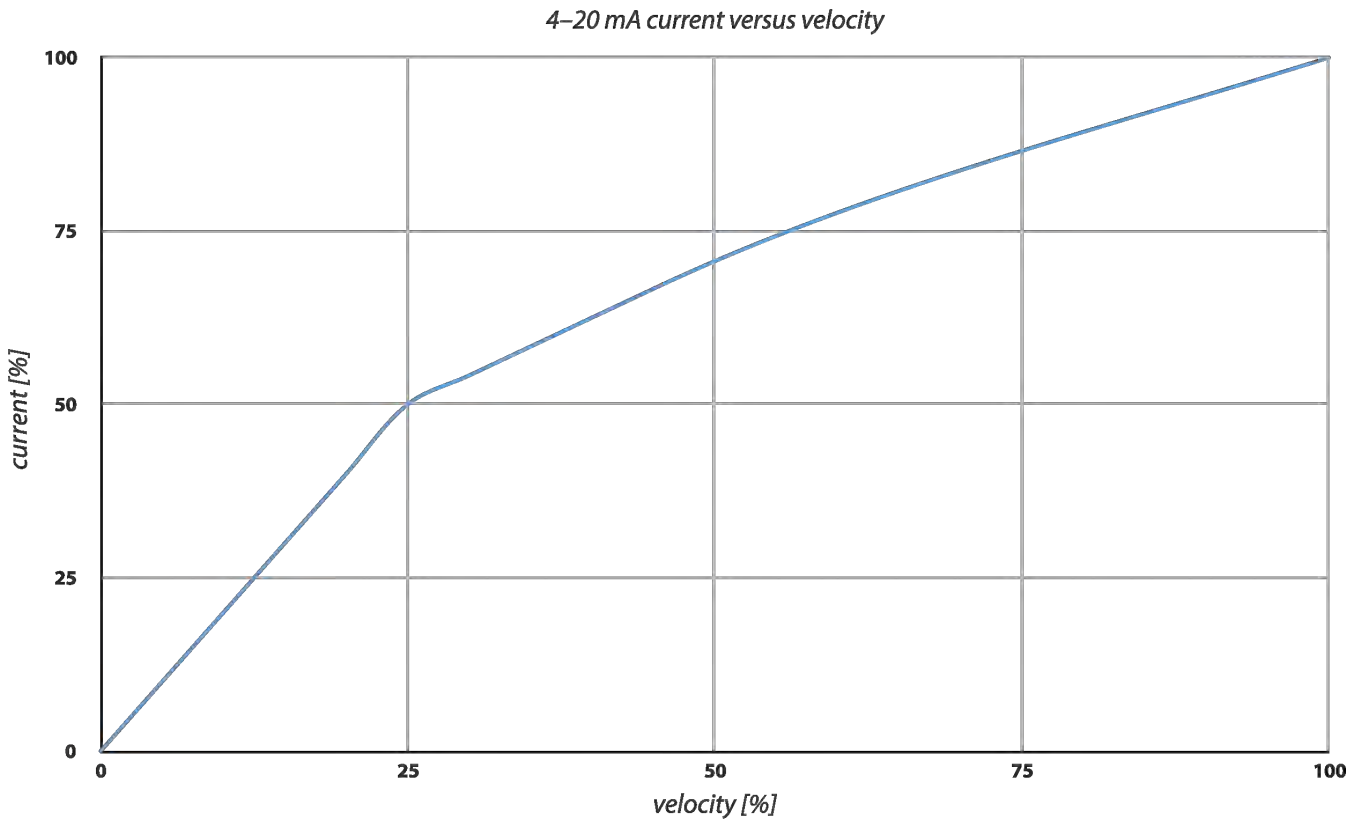

Starting up

After powering the flowswitch make a self-test and self-diagnostics LED, then goes fluently to the measuring mode.

Compact version :

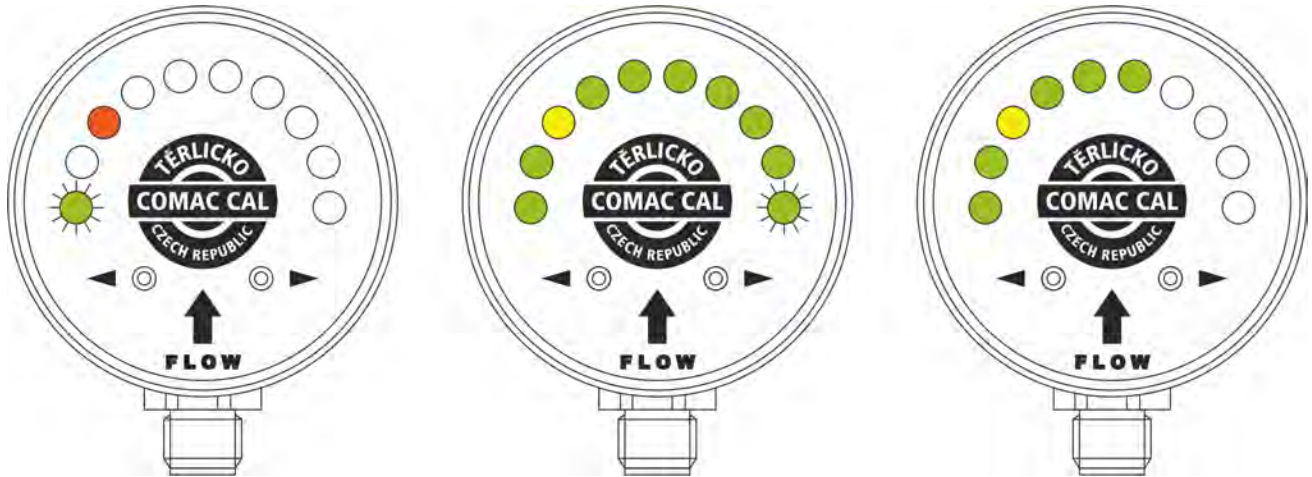

first LED flashing = the flow is below the monitor range

last LED flashing = the flow is above the monitor range

the flow velocity is within the adjusted monitor range

The number of green illuminated LEDs roughly indicates the flow rate within the given range.

If none of the LEDs is lit or flashing, the device is most likely disconnected from the supply voltage!!!

Basic parameter default setting

The flow monitor parameters are set by the manufacturer according to purchase order. The device is set to default parameters by the manufacturer (see the Table below). The operator may make alterations by means of two buttons on the panel of the device (page 11).

Factory settings for water

Minimum flow speed	<8cm/sec (2% Qmax)	First LED flashing
Switching point	40cm/sec (10% Qmax)	Red/amber LED
Maximum flow speed	>400cm/sec (100% Qmax)	Last LED flashing

Note: The value of switching point in the table are only informative and depend on the fact if the flow rate increase or decrease with time, i.e. this switching point have a hysteresis, which is set by the manufacturer.

Table view of LEDs according to the percentage of settings of maximal flow.
 (Factory setting of speed is standardly $Q_{max} = 4\text{m/s}$)

LED display	Flow velocity in % of setting Q_{max}
Flashing LED 1	below 2%
Lighting LED 1	2-5%
Lighting LED 2	5-10%
Lighting LED 3	10-15%
Lighting LED 4	15-20%
Lighting LED 5	20-25%
Lighting LED 6	25-35%
Lighting LED 7	35-47,5%
Lighting LED 8	47,5-62,5%
Lighting LED 9	62,5-80%
Lighting LED 10	80-100%
Flashing LED 10	above 100%

FS 20 monitor adaptation and control

Switching point

Press down the button ◀ and hold until the green LEDs start flashing. After the button is released, the red LED indicating switching/circuit-opening point starts flashing. Using the ◀ ▶ buttons you can move this switching point to the positions of LED 2 to 9. After completion of the setting, wait until automatic storage operation is over and the meter goes to measuring mode.

Customizing to a medium different from water (oil, glycol-based mixtures, etc.)

For the liquids with different thermal conductivity than water, it is necessary to perform adaptation (curve shift) to the medium in question. With zero flow and filled sensor press simultaneously the ◀ ▶ buttons on the control panel and hold them until green LEDs start flashing. After releasing the buttons, adaptation to the liquid in question is completed.

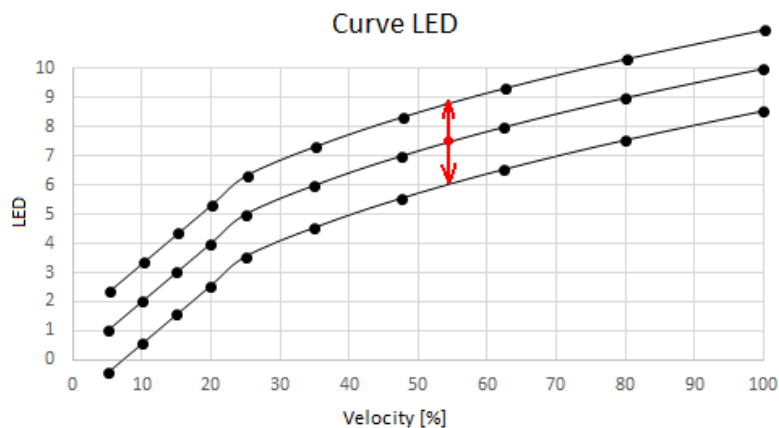

Calibration of the minimum flow of the monitor

In order to calibrate the minimum flow, press down the ◀ button and hold it until the red LEDs start flashing. After releasing the button, the minimum flow will be automatically registered and the sensor returns to measurement mode. minimum calibration is completed by this action. Carry out this setting only if necessary (usually, after using with an oil medium, etc.), this default factory setting done for water.

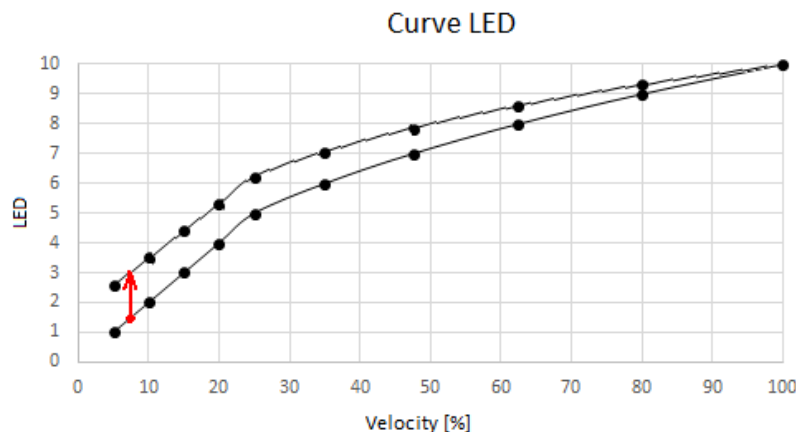

Calibration of the maximum flow of the monitor

In order to calibrate the maximum flow, press down the **▶** button and hold it until the red LEDs start flashing. After releasing the button, the maximum flow will be automatically registered and the sensor returns to measurement mode. maximum calibration is completed by this action. Carry out this setting only if necessary (usually, after using with an oil medium, etc.), this default factory setting done for water.

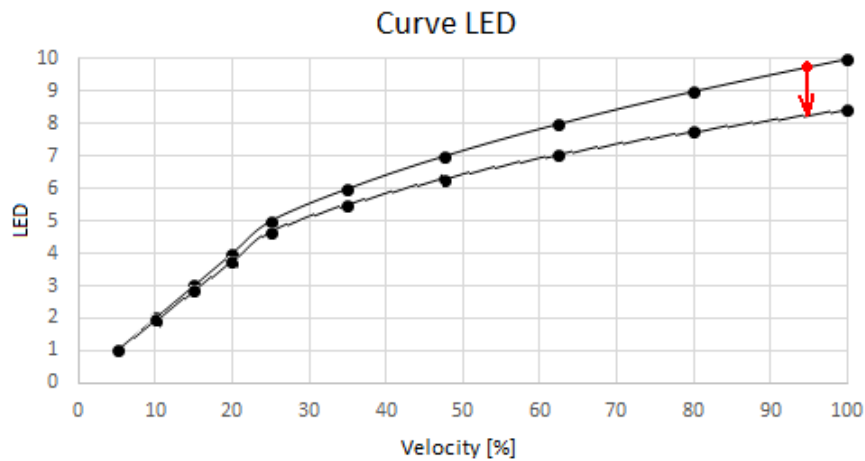

Restoring parameters to factory default values

Press down simultaneously the **◀ ▶** buttons on the meter panel and hold them until red LEDs start flashing (red LEDs flashing precedes green LEDs flashing, serving for changing the polarity of NC/NO contact). After releasing both buttons, **RESET** is applied and factory defaults are restored.

Basic dimensions

Compact version

Connection by cutting ring

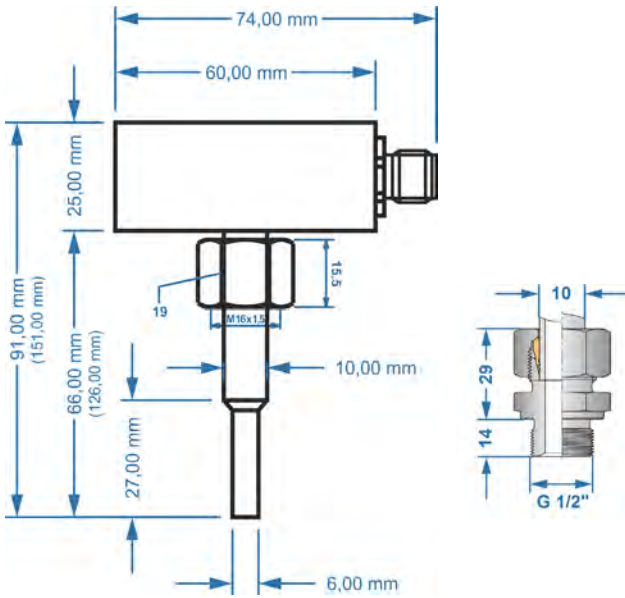

Clamp connection

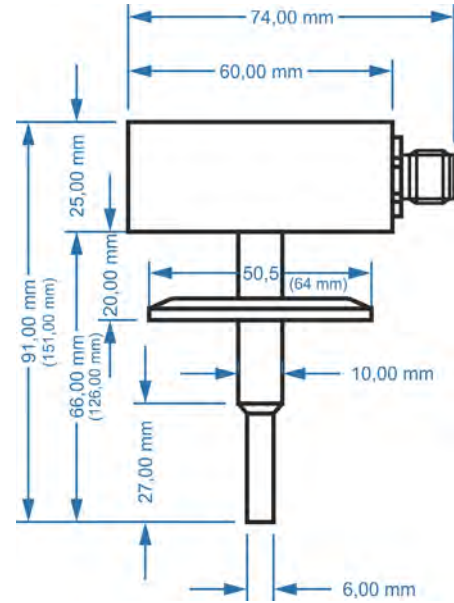

Separate version for DIN rail or wall mounting

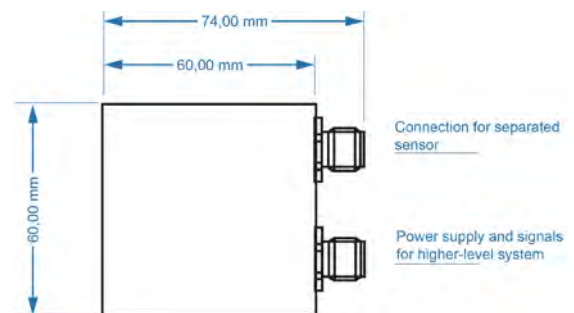
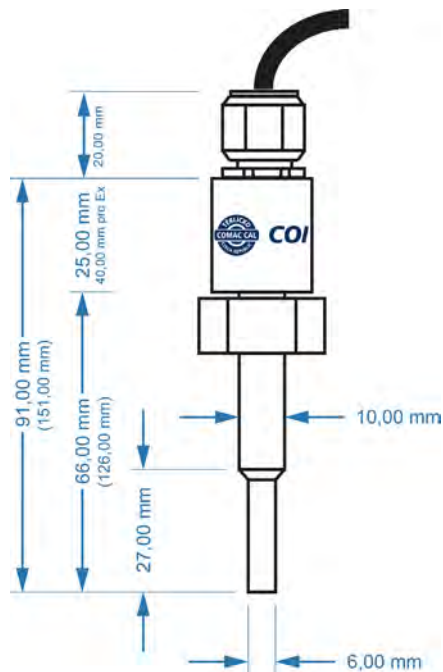

Additional accessories

Adapter block

In case when it is necessary to monitor the media flow in pipe with a smaller DN than DN 25 (or the flow velocity is below the sensor range at the pipe diameter given), it is possible to use an adapter block with a corresponding flow velocity and ensure correct operation and keep the installation conditions in this way.

Adapters are designed for short version of sensor 65mm with using direct socket with pipe thread G 1/2.

Individual designs :

FS adapter block DN20/G3/4" for 5 ÷ 100 l/min. (size 150×50×40 mm)

FS adapter block DN15/G1/2" for 2 ÷ 40 l/min. (size 150×50×30 mm)

FS adapter block DN10/G1/4" for 0,4 ÷ 20 l/min. (size 150×50×30 mm)

FS adapter block DN4,5/G1/4" for 0,1 ÷ 5 l/min. (size 70×50×30 mm)

FS adapter block DN2,7/G1/4" for 0,075 ÷ 2 l/min. (size 70×50×30 mm)

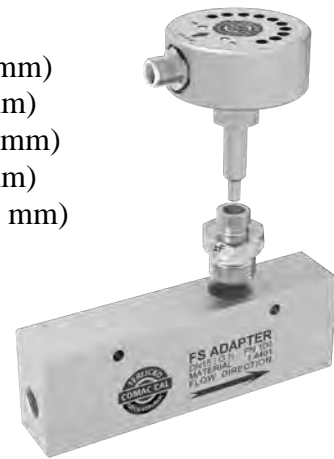

Order code

